

# GARAGE BEAM FORM SYSTEMS

## SYSTEM COMPONENTS

- Beams, Split or Solid Style
- End Beams
- Frames
- Top Jacks
- Bottom Jacks
- Jack Retainers
- Stringer Support Arms
- Stripping Saddle Brackets
- Saddle Beams
- Stringers
- Crossbraces
- Push/pull Aligner Braces
- High Strength Fasteners
- Moving Dollies
- Stripping Trusses

- BEAM FORM:**
- Solid or Split
  - End Beams
  - Side Entry Beams
  - Standard & Custom Lengths

- JACKS:**
- 18kip Capacity @ FOS=2.5:1
  - Standard or Anti-topple Top Jacks

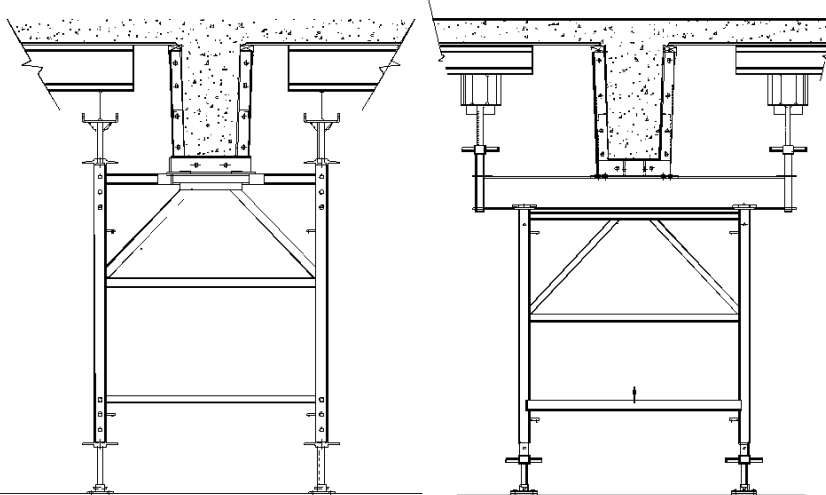

CONVENTIONAL LAYOUT

SADDLE-BEAM

- FRAMES:**
- 18kip Leg Capacity @ FOS=2.5:1
  - 4' & 5' Wide Options
  - Center Load Frames
  - Adjustable Header Frames

## WADCO INDUSTRIES, INC GARAGE BEAM FORM SYSTEMS

Consider the advantages of owning over renting:-

- no rental damage charges
- no lost part charges, (often at full list price)
- no hard-to-understand billings
- no time-related costs for project overruns & delays
- no rusted and/or poorly maintained parts

**OWNED EQUIPMENT  
BUILDS  
COMPANY EQUITY**

**FOR PRICING &  
AVAILABILITY CALL TOLL-FREE**

**(877)874-7888**

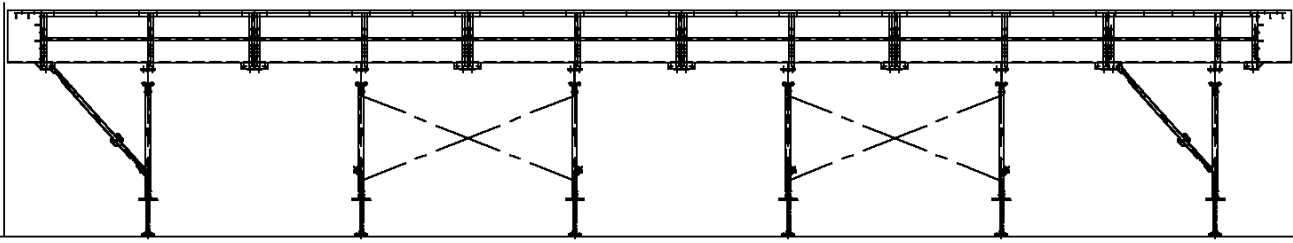

(A) WORKING CONFIGURATION  
SCALE: 3/4"

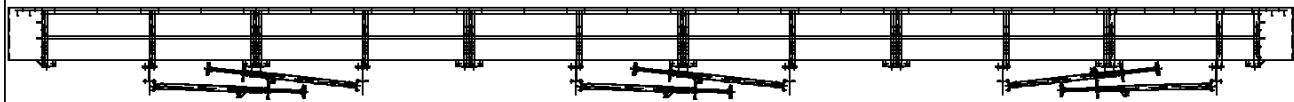

(B) STRIP CONFIGURATION  
SCALE: 3/4"



INDUSTRIES, INC.

2625 SOUTH WILLOW AVE.  
BLOOMINGTON, CA. 92316  
TEL: (909)874-7800  
FAX: (909)874-8046

CUSTOMER:

TITLE: BEAM FORM SYSTEM  
GENERAL ASS'Y- ELEVATION

DRAWN:

DATE:

CHECKED:

REV DATE:

REV No:

JOB No:

DRG No:

BF1149

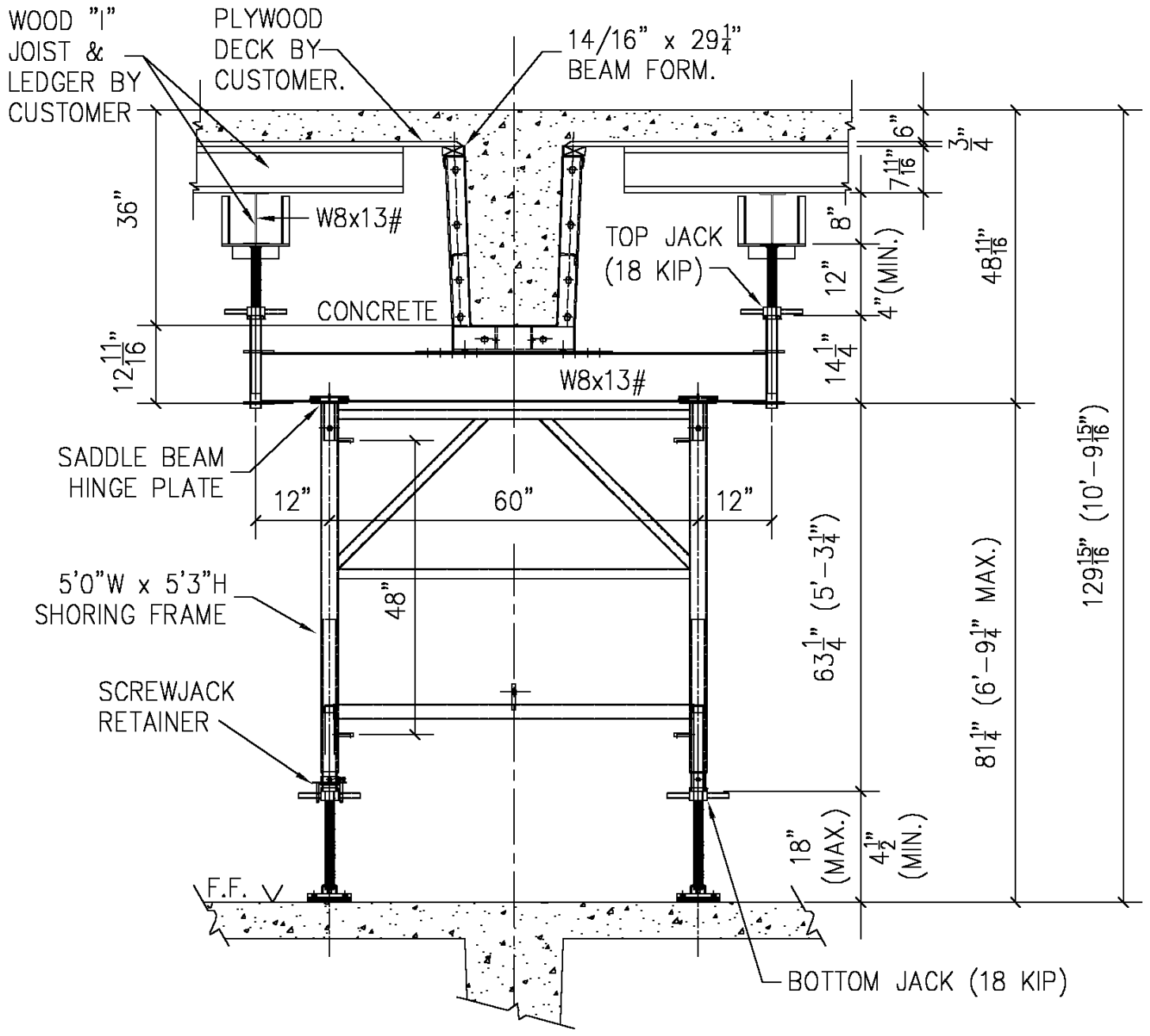

2625 SOUTH WILLOW AVE.  
 BLOOMINGTON, CA. 92316  
 TEL: (909)874-7800  
 FAX: (909)874-8046

CUSTOMER:		REV DATE:
TITLE: BEAM SYSTEM SECTION GENERAL ARRANGEMENT		REV No:
DRAWN: LDR		JOB No:
DATE: 3/15/00		DRG No:
CHECKED:		WS-261



# GENERAL CONSTRUCTION FORM SYSTEMS

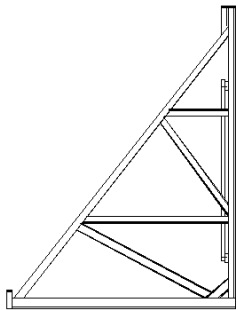

**1-SIDED BRACE FRAMES**

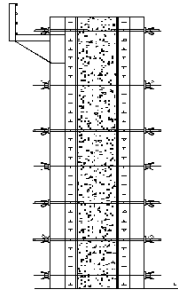

**WALL FORMS**

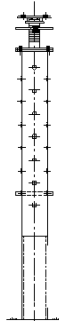

**100K POST SHORES**

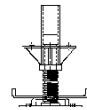

**35K RESHORE**

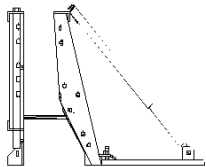

**BARRIER RAILS**

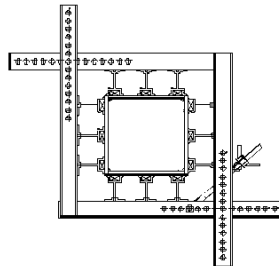

**HD COLUMN SYSTEMS**

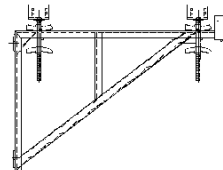

**BRIDGE O/HANG JACKS**

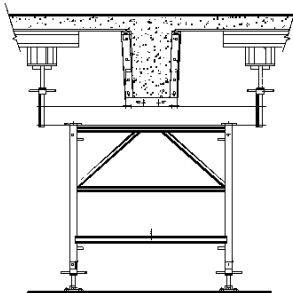

**GARAGE BEAM**

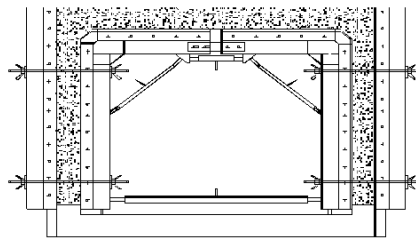

**BOX CULVERT SYSTEMS**

## WADCO INDUSTRIES, INC FABRICATED FORM SYSTEMS

Wadco's competitive pricing allows ownership to become a practical possibility. Consider some of the advantages of owning over renting:-

- no third party control of inventory
- no rental damage charges
- no replacement charges for lost parts
- no hard-to-understand billings
- no time-related costs for project overruns & delays
- no rusted and/or poorly maintained parts

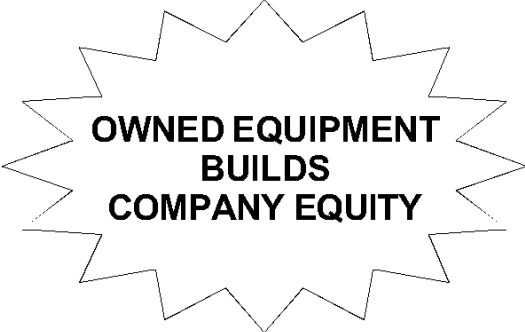

**FOR PRICING &  
AVAILABILITY CALL TOLL-FREE  
(877)874-7888**